

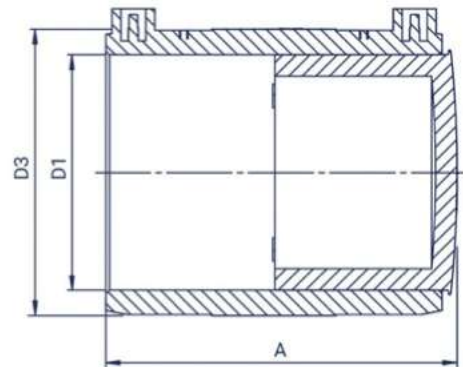

- material: PE 100-RC
- application: water and gas
- 16 bar water, 10 bar gas
- MRS - 10 MPa



Code	D1 (mm)	D3 (mm)	A (mm)	Quantity per parcel
ZE02011	20	35.5	88	200
ZE02511	25	35.5	88	200
ZE03211	32	42.5	88	180
ZE04011	40	52.5	96	150
ZE05011	50	64	97	90
ZE06311	63	79	118	50
ZE07511	75	97	139	30
ZE09011	90	112	154	18
ZE11011	110	134	164	12
ZE12511	125	152	170	18
ZE14011	140	168	179	14
ZE16011	160	195	178	6
ZE18011	180	213	260	4
ZE20011	200	238	275	3
ZE22511	225	266	314	2
ZE25011	250	295	331	2
ZE28011	280	336	363	2
ZE31511	315	379	386	1
ZE35511	355	425	439	2
ZE40011	400	476	470	1
ZE45011	450	537	325	1
ZE50011	500	600	383	1

